

# SALTO XS4 Original+

## Signalling

The XS4 Original+ product is a universal compatible state-of-the-art electronic escutcheon that brings the smart lock to a new technology level, combining the latest innovation in security, connectivity, and design into a battery-operated access control device.

EN Signalling ES Señalética DE Signalisierung FR Signal NL Signaal DK Signalering IT Segnaletica PT Sinal SV Signal NO Signal FI Signaalit

EN) Acces granted ES) Apertura normal DE) Zutritt gewährt FR) Accès accordé NL) Toegang verleend DK) Adgang tildelt	IT) Accesso garantito PT) Acesso autorizado SV) Tillträde beviljat NO) Adgang godkjent FI) Pääsy sallittu	EN) Access denied ES) Rechazo DE) Zutritt verweigert FR) Accès refuse NL) Toegang geweigerd DK) Adgang afvist	IT) Accesso negato PT) Acesso negado SV) Tillträde nekat NO) Adgang nektet FI) Pääsy evätty	EN) Low battery status ES) Pilas bajas DE) Niedriger Batteriestand FR) Statut pile faible NL) Laag batterijniveau DK) Lav batteristatus	IT) Status batteria bassa PT) Status de bateria fraca SV) Låg batteristatus NO) Lavt batterinivå FI) Matala pariston tila	EN) Battery change ES) Cambio de pilas DE) Batteriewechsel FR) Remplacement de la pile NL) Batterijwissel DK) Batteriskift	IT) Cambio batterie PT) Troca de bateria SV) Batteribyte NO) Batteribytte FI) Pariston vaihto
--	---	--	---	--	---	---	---

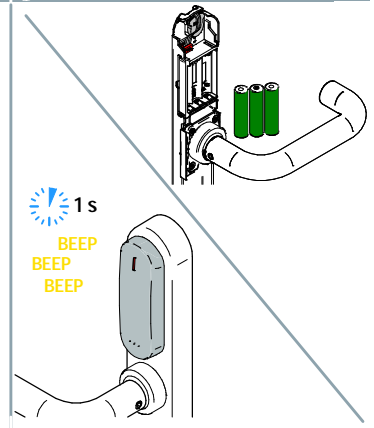
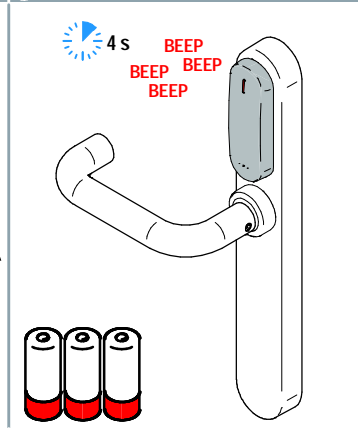
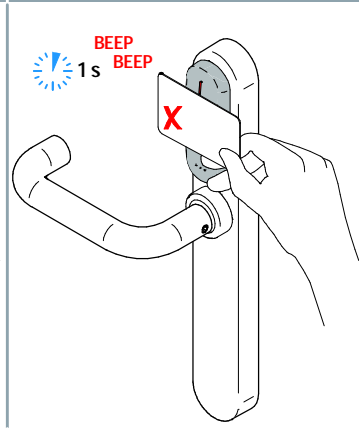
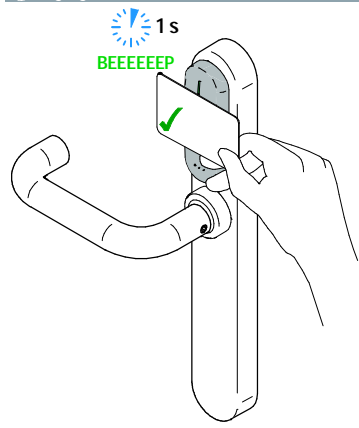

EN) Office mode notice ES) Puesta en paso DE) Office-Modus aktiviert FR) Notice du Mode Office NL) Loopstand ingeschakeld DK) Kontortilstand aktiveret	IT) Avviso Modalità ufficio PT) Aviso de modo office SV) Notis om kontorsläge NO) Kontor funksjon aktivert FI) Päiväkäyttötilan ilmoitus
---	--

EN) Office mode end ES) Fin paso DE) Office-Modus deaktiviert FR) Fin du mode office NL) Loopstand uitgeschakeld DK) Kontortilstand afsluttet	IT) Fine modalità ufficio PT) Fim do modo office SV) Avsluta kontorsläge NO) Kontor funksjon avsluttet FI) Päiväkäyttötilan lopetus
--	---

EN) Toggle mode ES) Modo toogle DE) Medientesteuerter Modus FR) Mode alterné NL) Toggle-stand DK) Toggle tilstand aktiveret	IT) Azione PT) Alternar SV) Toggle NO) Veksle FI) Tilanvaihto
--	---

EN) Toggle mode end ES) Fin modo toogle DE) Medientesteuerter Modus beendet FR) Fin du mode alterné NL) Einde Toggle-stand	DK) Slut på toggle tilstand IT) Fine azione PT) Terminar o modo alternar SV) Avsluta toggle NO) Veksle modus avsluttet FI) Tilanvaihtu lopetettu
--	---

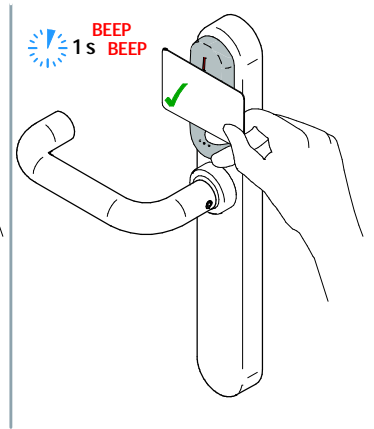
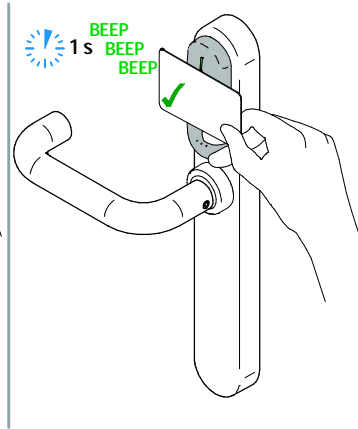
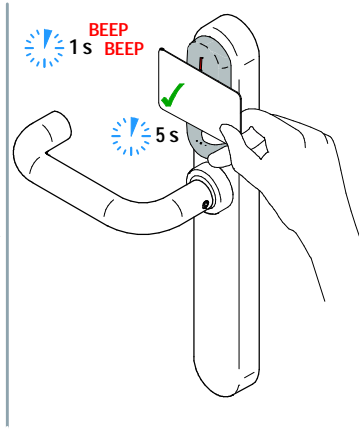
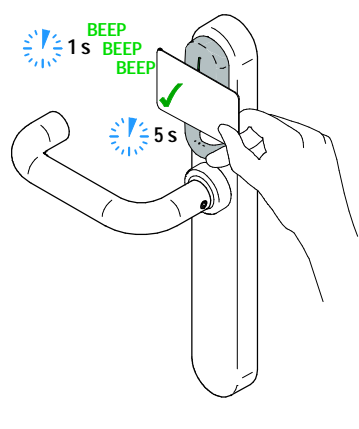

EN) Program PPD ES) Programar PPD DE) Programmieren PPD FR) Programmer PPD NL) Programmeren PPD DK) Tidsplan PPD	IT) Programmare PPD PT) Programar PPD SV) Schema PPD NO) Plan PPD FI) Aikataulu PPD
---	---

EN) Security error ES) Error de seguridad DE) Sicherheitsfehler FR) Erreur de sécurité NL) Beveiligingsfout DK) Sikkerhedsfej	IT) Errore sicurezza PT) Erro de segurança SV) Säkerhetsfel NO) Sikkerhets feil FI) Turvallisuusvirhe
--	---

